



# Xlazy Home

## 002 Self powered wireless doorbell

**Note:** Please read this manual carefully before using the product, and install and use the product according to the instructions.

### Product Description:

#### 1. Product Features:

Battery-free wireless doorbell. Generating power by pressing to drive wireless signals. No batteries needed. No Wiring. Simple installation. Green and Eco-friendly.

#### 2. Product diagram:

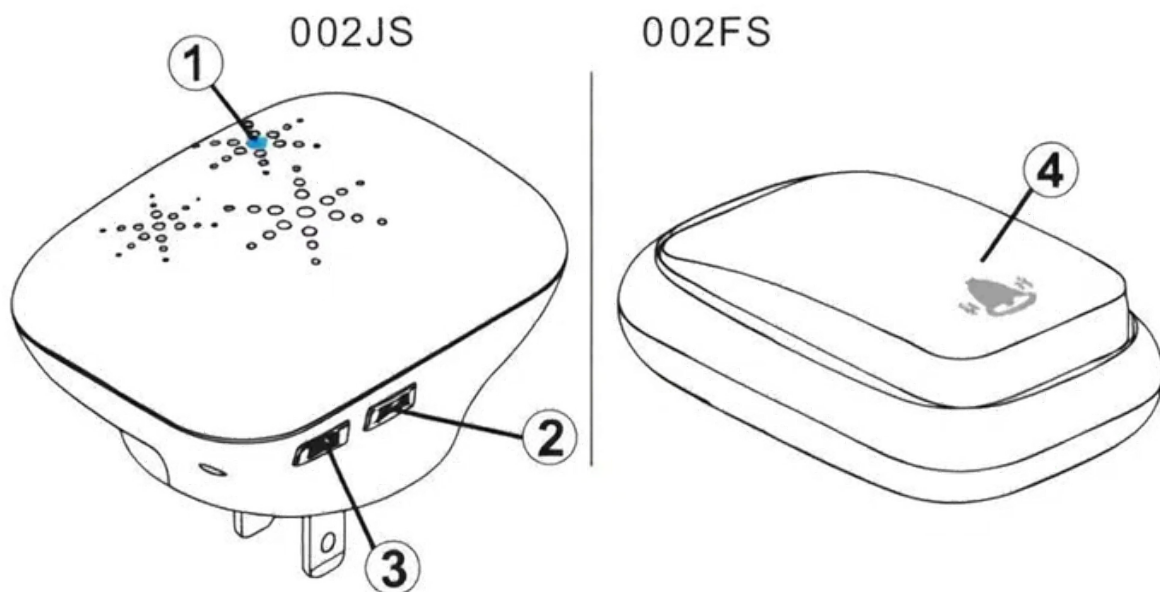

- ① Indicator
- ② Pairable button and music selection button
- ③ Volume button and back
- ④ Transmitter button

### 3. Technical parameter:

## 002 Technical parameter

Technical parameter	Doorbell transmitter	Doorbell receiver
Power supply	self-powered generation	<b>AC100V-230V 50/60Hz</b>
Power consumption		<b>0.25W</b>
Music		38 Melodies
Weight	<b>35g</b>	<b>50-55g</b>
Distance of transmission	Operating range(No obstacles)≥150M	
Working frequency	<b>433MHZ</b>	
Appearance dimension	<b>L70mmxW46mmxH20mm</b>	<b>L66mmxW50mmxH60-70mm</b>
Ringtone volume		<b>≥50dB/1m</b>
Working temperature	<b>-20°C~+60°C</b>	<b>-10°C~+45°C</b>

### User Instruction

1.Paring: When the receiver is powered on, press and hold the pairing button, and if the indicator light is constantly on, it is in pairing mode. Then press the transmitter button, the indicator light flashes once to indicate that the pairing is successful. The receiver can be paired with up to 5 transmitters. When the receiver has been paired with 5 transmitters, adding a new transmitter will automatically replace the first one.

#### 2.Schematic Description:

- (1) Within 1 minute after the receiver is powered on, press and hold the pairing button for 3 seconds.
- (2) The indicator light is constantly on indicates that it is in pairing mode.

③ Press the transmitter, the blue light flashes on the receiver, and the pairing is successful.

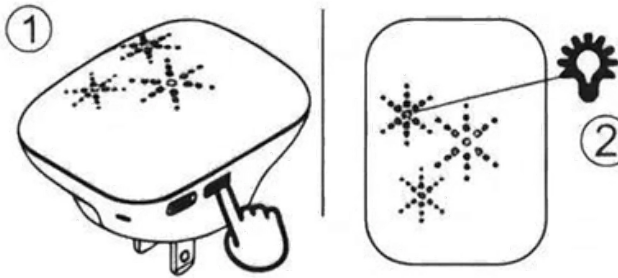

3. Clear the pairing: As shown in the picture, within 1 minute after the receiver is powered on, press and hold the pairing-button until the light flashes 3 times to clear all the pairing.



Then press any button again and the light will turn off, indicating the clearing is completed.

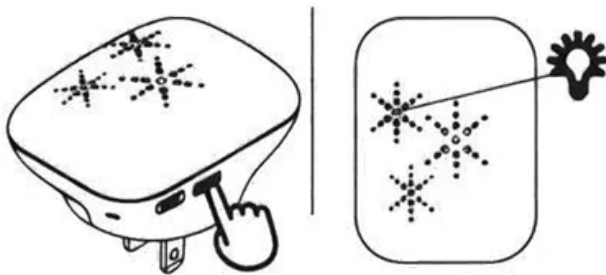

Return to the first chime: When the receiver is powered on, press and hold the volume button to return to the first chime.

4. Chime selection: When the receiver is powered on, press the chime selection button to change the chime among the built-in 38 chimes.

5. Volume Control: When the receiver is powered on, press volume button to change the volume between large, medium, and low volume.

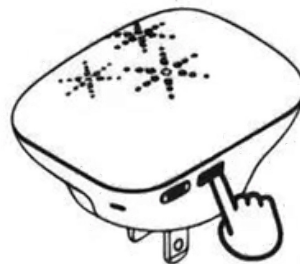
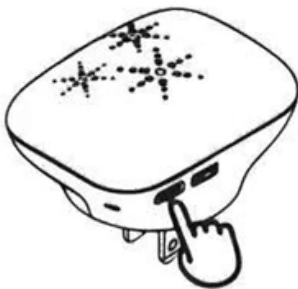

## 002FS transmitter Installation:

The 002FS transmitter can be placed or moved at will, or it can be fixed in your favorite position.

1. Method 1 (double-sided stickers): As shown: stick one side of the double-sided stickers to the bottom of the transmitter, then stick the transmitter anywhere you like.

double-sided stickers

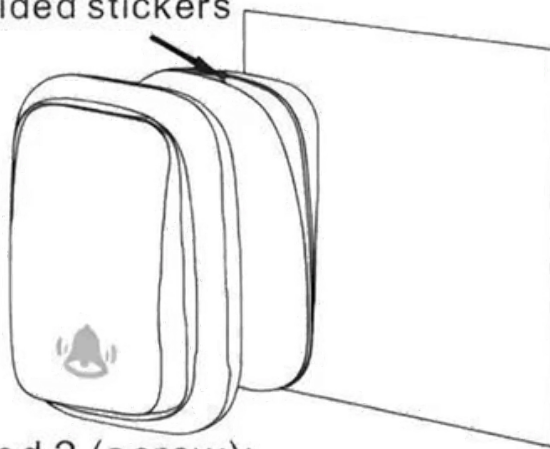

Tip: Please avoid installing on metal objects (iron gates, iron windows, etc.) to avoid affecting the launch distance. Please try it before fixed transmitter.

**\*optional accessories\***

2. Method 2 (screw):

Put the bracket plate in the desired position and draw the anchor point. Use professional tools to punch holes on the wall and install rubber plugs to fix the bracket plate to the wall with screws, and then slide the transmitter in place.

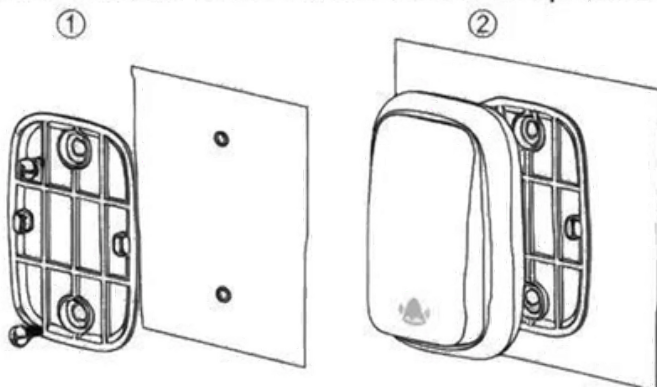

FAQ:

- 1.No sound:Check whether the receiver is plugged well, make sure the receiver is powered on.
- 2.Check whether the pairing is successful, try clearing the pairing and then re-pairing again.

3.Short transmission distance: Metal objects such as iron doors and iron frames will affect the effective transmission distance. Avoid placing the transmitter and receiver near metal objects. Walls and ceilings also affect the transmission distance. Interference from other wireless devices, etc.